

marantz®

Model SA-11S2 User Guide

Super Audio CD Player

CLASS 1 LASER PRODUCT
LUOKAN 1 LASERLAITE
KLASS 1 LASERAPPARAT



SUPERAUDIO CD

COMPACT
disc
DIGITAL AUDIO

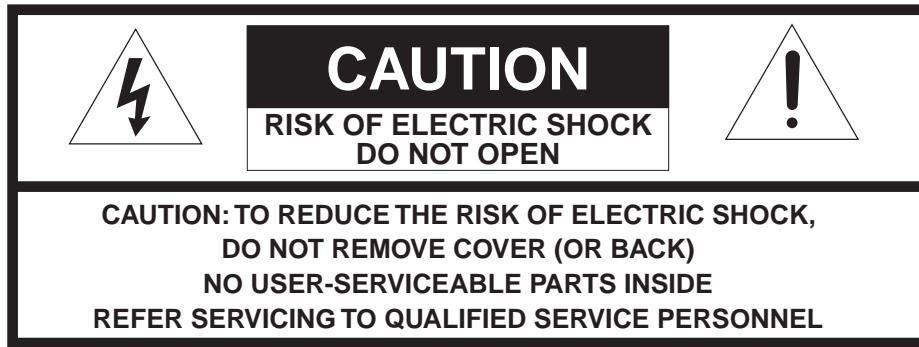

The lightning flash with arrowhead symbol within an equilateral triangle is intended to alert the user to the presence of uninsulated "dangerous voltage" within the product's enclosure that may be of sufficient magnitude to constitute a risk of electric shock to persons.



The exclamation point within an equilateral triangle is intended to alert the user to the presence of important operating and maintenance (servicing) instructions in the literature accompanying the product.

WARNING

TO REDUCE THE RISK OF FIRE OR ELECTRIC SHOCK, DO NOT EXPOSE THIS APPLIANCE TO RAIN OR MOISTURE.

CAUTION: TO PREVENT ELECTRIC SHOCK, MATCH WIDE BLADE OF PLUG TO WIDE SLOT, FULLY INSERT.

ATTENTION: POUR EVITER LES CHOCES ELECTRIQUES, INTRODUIRE LA LAME LA PLUS LARGE DE LA FICHE DANS LA BORNE CORRESPONDANTE DE LA PRISE ET POUSSER JUSQU'AU FOND.

LASER SAFETY

This unit employs a laser. Only a qualified service person should remove the cover or attempt to service this device, due to possible eye injury.

CAUTION : USE OF CONTROLS OR ADJUSTMENTS OR PERFORMANCE OF PROCEDURE OTHER THAN THOSE SPECIFIED HEREIN MAY RESULT IN HAZARDOUS RADIATION EXPOSURE.

NOTE:

This equipment has been tested and found to comply with the limits for a Class B digital device, pursuant to Part 15 of the FCC Rules. These limits are designed to provide reasonable protection against harmful interference in a residential installation. This equipment generates, uses and can radiate radio frequency energy and, if not installed and used in accordance with the instructions, may cause harmful interference to radio communications. However, there is no guarantee that interference will not occur in a particular installation. If this equipment does cause harmful interference to radio or television reception, which can be determined by turning the equipment off and on, the user is encouraged to try to correct the interference by one or more of the following measures:

- Reorient or relocate the receiving antenna.
- Increase the separation between the equipment and receiver.
- Connect the equipment into an outlet on a circuit different from that to which the receiver is connected.
- Consult the dealer or an experienced radio/TV technician for help.

NOTE:

Changes or modifications may cause this unit to fail to comply with Part 15 of the FCC Rules and may void the user's authority to operate the equipment.

This Class B digital apparatus complies with Canadian ICES-003.

Cet appareil numerique de la Classe B est conforme a la norme NMB-003 du Canada.

IMPORTANT SAFETY INSTRUCTIONS

READ BEFORE OPERATING EQUIPMENT

This product was designed and manufactured to meet strict quality and safety standards. There are, however, some installation and operation precautions which you should be particularly aware of.

1. Read these instructions.
2. Keep these instructions.
3. Heed all warnings.
4. Follow all instructions.
5. Do not use this apparatus near water.
6. Clean only with dry cloth.
7. Do not block any ventilation openings. Install in accordance with the manufacture's instructions.
8. Do not install near any heat sources such as radiators, heat registers, stoves, or other apparatus (including amplifiers) that produce heat.
9. Do not defeat the safety purpose of the polarized or grounding-type plug. A polarized plug has two blades with one wider than the other. A grounding type plug has two blades and a third grounding prong. The wide blade or the third prong are provided for your safety. If the provided plug does not fit into your outlet, consult an electrician for replacement of the obsolete outlet.
10. Protect the power cord from being walked on or pinched particularly at plugs, convenience receptacles, and the point where they exit from the apparatus.
11. Only use attachments/accessories specified by the manufacturer.
12. Use only with the cart, stand, tripod, bracket, or table specified by the manufacturer, or sold with the apparatus. When a cart is used, use caution when moving the cart/apparatus combination to avoid injury from tip-over.



13. Unplug this apparatus during lightning storms or when unused for long periods of time.
14. Refer all servicing to qualified service personnel. Servicing is required when the apparatus has been damaged in any way, such as power-supply cord or plug is damaged, liquid has been spilled or objects have fallen into the apparatus, the apparatus has been exposed to rain or moisture, does not operate normally, or has been dropped.

Additional Safety Information!

- This product should not be placed in a built-in installation such as a bookcase or rack unless proper ventilation is provided or the manufacturer's instructions have been adhered to.
- Apparatus shall not be exposed to dripping or splashing and that no objects filled with liquids, such as vases, shall be placed on the apparatus.
- When the switch is in the OFF position, the apparatus isn't completely switched-off from the MAINS.
- The equipment shall be installed near the power supply so that the power supply is easily accessible.

DECLARATION OF CONFORMITY

This device complies with Part 15 of the FCC rules. Operation is subject to the following conditions: (1) This device may not cause harmful interference, and (2) this device must accept any interference received, including interference that may cause undesired operation.

U.S. Responsible Party: Marantz America, Inc. 100 Corporate Drive, Mahwah, NJ, 07430, U.S.A. TEL: 201-762-6500
--

Type of Product: Super Audio CD Player

Model: SA-11S2

Thank you for selecting the Marantz SA-11S2 Super Audio CD Player for your Audio system. This Player incorporates a number of features designed to enhance the listening of your favorite audio sources.

Please read these operating instructions carefully. We recommend that you read the entire user guide before you attempt to connect or operate the player.

After you have reviewed the contents of this manual, we suggest that you make all system connections before you attempt to operate the unit.

■ Checking the accessories

After opening the cover of the packing box, check that the following accessories are included.

- Remote controller

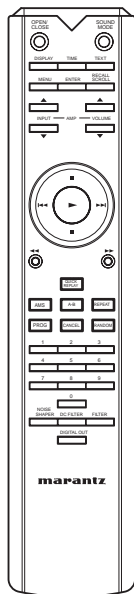

- Audio connecting cord

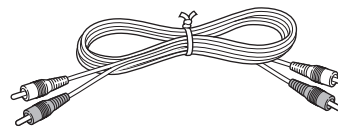

- User Guide

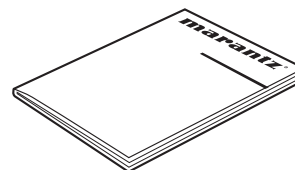

- Size "AAA" batteries x 2

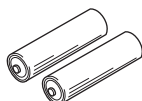

- AC Power cord

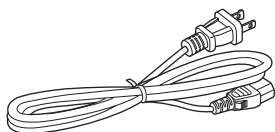

CONTENTS

INTRODUCTION.....	3
PRODUCT FEATURES	3
APPLICABLE DISCS TO THE UNIT	3
BEFORE USING.....	4
EQUIPMENT MAINS WORKING SETTING	4
COPYRIGHT	4
INAPPROPRIATE PLACES FOR INSTALLATION	4
PRECAUTIONS.....	4
NOTES ABOUT THE DISCS.....	5
ABOUT PLAYING COPY-CONTROLLED CDS.....	5
NAMES AND FUNCTIONS	7
FRONT PANEL.....	7
DISPLAY.....	8
REAR PANEL.....	9
REMOTE CONTROLLER.....	10
CONNECTIONS.....	12
CONNECTING THE POWER SUPPLY	13
TIMER PLAY	13
OPERATION	14
NORMAL PLAYBACK.....	14
SWITCHING SOUND MODE (SUPER AUDIO CD).....	15
START SOUND MODE	15
PLAYING YOUR FAVORITE TRACKS OF A DISC.....	16
PLAYING YOUR FAVORITE PARTS OF A DISC (SEARCH)	16
REPEATED DISC PLAY (REPEAT PLAY).....	16
PLAYING TRACKS IN A RANDOM SEQUENCE (RANDOM PLAY).....	17
PLAYING TRACKS IN A SPECIFIC SEQUENCE (PROGRAM PLAY)	17
SEARCHING YOUR FAVORITE TRACKS (AMS (AUTOMATIC MUSIC SCAN) PLAY)	18
QUICK REPLAY	19
ABOUT THE TEXT INFORMATION DISPLAY.....	19
TURNING OFF THE DISPLAY AND ILLUMINATION (DISPLAY OPERATION).....	20
MAKING YOUR FAVORITE AUDIO SETTINGS	20
USING A MASTER CLOCK GENERATOR WHEN PLAYING DISCS	22
ABOUT BALANCED JACKS	23
ANALOG OUTPUT CONNECTOR PHASE SWITCHING.....	23
TROUBLE SHOOTING	24
SPECIFICATIONS	25

INTRODUCTION

PRODUCT FEATURES

This unit can playback the outstanding sound performance in Super Audio CD. This unit has the following unique features.

- **Low-noise low-distortion filter circuit and high-speed HDAM SA2-type output amplifier with the differential input type HDAM.**
- **Text information display function that can display disc titles, track titles etc. in Super Audio CD.**
- **CD-R/CD-RW discs can be played.**
- **Discs can be played using an external clock.**
- **Phase inversion of analog signal can be performed.**

APPLICABLE DISCS TO THE UNIT

1. Super Audio CD



SUPER AUDIO CD

The Super Audio standard is based on Direct Stream Digital (DSD) technology. This new direct-stream digital format comprises a 1-bit system that has a digital sampling frequency that is 64 times higher than that of conventional audio CD. The results are spectacular: a frequency response of over 100k Hz and a 120 dB dynamic range over the entire audible spectrum. Mixed with as many of the original frequencies as possible, the audio information audible for human ears sounds much more natural.

All audible frequencies are, after all, embedded in the frequency range as emitted by the sound source. A better reproduction does not exist! For the first time your ears will relive reality.

There are three types of Super Audio CDs.

- **Single-layer Disc**
- **Dual-layer Disc**
- **Hybrid-layer Disc**

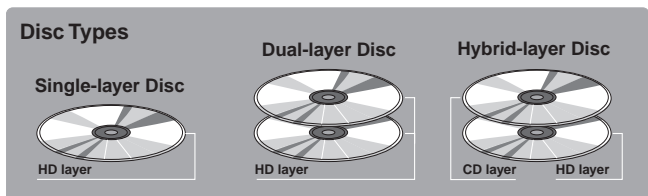

And each type may contain two areas of recorded information.

- **High quality stereo area**
- **High quality multi-channel area****

• Single Layer Disc

It can contain both high quality stereo area and high quality multi-channel area** information.

• Dual Layer Disc

It can contain both high quality stereo area and high quality multi-channel area** information. And a double amount of information can be stored on the disc thanks to the second layer.

• Hybrid Layer Disc

Not only does this disc contain both high sound quality stereo area and high sound quality multi-channel area** information, it also has a CD layer in the second layer, so it can be played on a CD player.

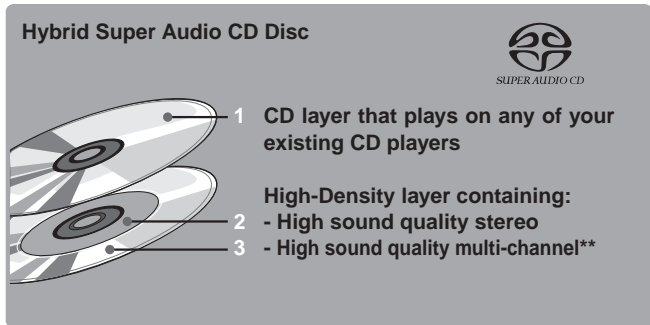

The number of tracks recorded may vary per layer. It will be shown on the display window of the unit.

**** This unit is a stereo-only player, and so it cannot play high-quality multi-channel audio areas. (It does not recognize multi-channel areas.)**

2. Audio CD (CDDA)



Audio CDs contain music tracks only.

3. CD-R / CD-RW

This unit can play back the CD-RW (ReWritable) discs as well as ordinary Audio CD and CD-R (Recordable) discs.

- The CD-R and CD-RW discs should contain properly-recorded TOC information so that they can be played back. In CD recorders, the task of writing TOC information is referred to as finalizing the disc. Discs that are not finalized cannot be properly recognized as an Audio CD and played back by regular CD players and Super Audio CD players. For details, please read the instruction manual provided with a CD recorder.

* TOC stands for Table Of Contents and contains information such as the total number of tracks and total playing time of the disc.

- This unit can play only the discs recorded in the CD-DA format designed for music reproduction. Do not attempt to play a disc containing other data, such as a CD-ROM for PCs, on this unit.
- As the playback of a CD-RW disc necessitates partial change of the player setup, it may take longer time for reading the TOC information than when an Audio CD or CD-R disc is played.

BEFORE USING

This section must be read before any connection is made to the mains supply.

EQUIPMENT MAINS WORKING SETTING

Your Marantz product has been prepared to comply with the household power and safety requirements that exist in your area.

This product can be powered by 120 V AC only.

COPYRIGHT

Recording and playback of any material may require consent. For further information refer to the following:

- Copyright Act 1956
- Dramatic and Musical Performers Act 1958
- Performers Protection Acts 1963 and 1972
- Any subsequent statutory enactments and orders

INAPPROPRIATE PLACES FOR INSTALLATION

To keep your player in perfect working order for the longest possible time, avoid installing the player in the following locations.

- Wherever it will be exposed to direct sunlight
- Wherever it will be close to a heater or other heat-radiating appliance
- Wherever the humidity is high or ventilation is poor
- Wherever it is very dusty
- Wherever it will be subject to vibration
- On top of a rickety stand or in an unstable location which is tilted at an angle
- In an audio rack with little space at the top and bottom or other location where the heat dissipation will be obstructed

To ensure proper heat dissipation, install the player while leaving clearances between the player and wall or other components, as shown in the figure below.

- On top of an amplifier or other component which dissipates a great deal of heat

*** The quality of the laser and other components can be harmed if the player is placed directly on top of an amplifier or other device which generates heat.**

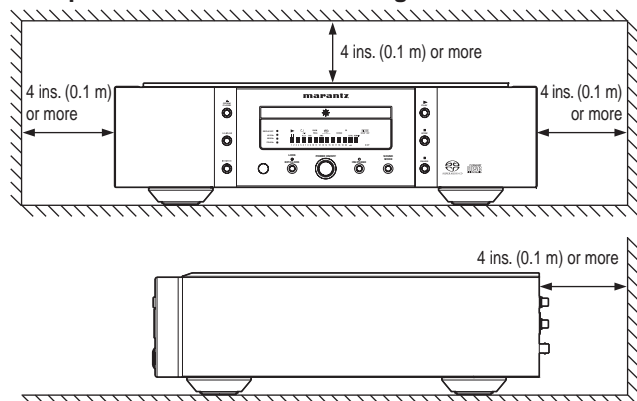

Do not place objects on top

- Refrain from placing any objects on top of the player.

Cautions on handling power cord

- Do not touch the power cord with wet hands.
- When disconnecting the power cord, always make sure that you take hold of the plug. Yanking out or bending the cord can damage it and/or cause electric shocks or a fire.
- Get into the habit of disconnecting the power plug before leaving home.

Do not attempt repairs yourself

- Refrain from lubricating the player: doing so can cause malfunctioning.
- Only qualified engineers with specialized expertise are authorized to repair the pick-up and parts inside the player.

PRECAUTIONS

- In winter, droplets of water form on the insides of the windows of a heated room: this is called condensation. This player uses an optical lens, so the condensation may form in the following cases.
 - In a room immediately after the heating has been turned on
 - In a room where the humidity level is high
 - When the player has been suddenly brought from a cold location into a warm room
 Since, in cases like this, the track numbers may not be read and the player is prevented from operating properly, wait about 30 minutes, and then operate the player.
- This player may cause interference on a tuner or TV set. If this is the case, place it further away from the tuner or TV set.
- Compact discs have much less noise than analog records and hardly any noise is heard before play starts. Bear in mind, therefore, that if the volume control on the amplifier is set too high, you will risk damaging other audio components.
- This player is designed to play Super Audio CD and normal Audio CDs only. It cannot play CD-ROMs used with personal computers, game CDs, video CDs or DVDs (video/audio).
- We do not recommend the use of lens cleaners.

BEFORE USING

NOTES ABOUT THE DISCS

* **Handle the discs carefully so as not to scratch their surfaces.**

* **Keep the surfaces of the discs clean at all times.**
 When cleaning the surfaces of discs, always be sure to use the special cleaner and wipe the surfaces in the directions shown in the figure below.

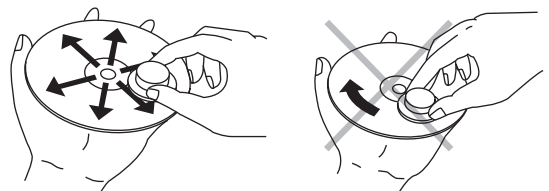

- Wipe the surface radially from the center.
- Do not wipe the surface in the circumferential direction.

* **Do not attach pieces of paper or stickers to the label surfaces of the discs.**

When a disc has a piece of plastic tape or rental CD label with paste protruding from the edge or when a disc still bears traces of sticky tape or adhesive labels, do not attempt to play it. If such a disc is played on the CD player, you may find that you cannot remove it or that some other kind of malfunctioning may occur.

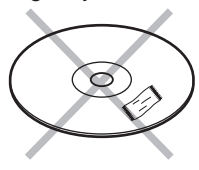

* **Do not use discs which come in special shapes.**

Do not attempt to play heart-shaped or octagonal discs or discs with any other special shapes. You may find that you cannot remove them or that some other kind of malfunctioning may occur in the player.

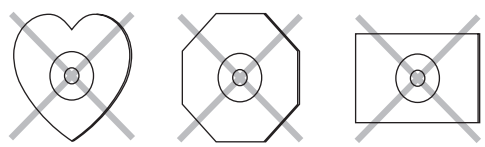

* **Use discs which satisfy the CD standards such as those with the “CD logo” or “” mark on their disc label surfaces.**

No guarantees are made for playback if discs which do not satisfy the appropriate CD standards are used.

Similarly, no guarantees are made for their sound quality even if it is possible to play such discs.

* **To protect your discs from damage, avoid placing them in the following locations.**

- Where they will be exposed to direct sunlight or where they will be close to a heater or other heat-radiating appliance
- Where the humidity level is high or it is very dusty
- Near a window or other such location where they may be exposed to rain

* **Get into the habit of putting the discs back in their cases after use.**

ABOUT PLAYING COPY-CONTROLLED CDS

Some copy-controlled CDs may not conform to official CD standards. They are special discs and may not play on the unit.

BEFORE USING

■ Loading batteries

Before using the remote controller for the first time, load the batteries in the remote controller. The batteries provided are used to verify the operations of the remote controller only.

- 1 Remove the battery cover.

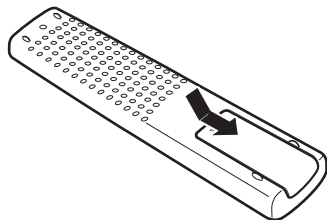

- 2 Insert the batteries with correct +/- orientation.

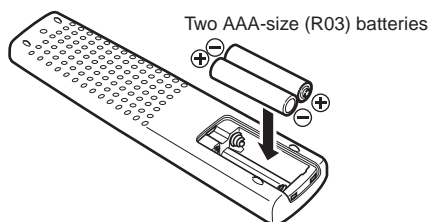

- 3 Close the battery cover until it clicks shut.

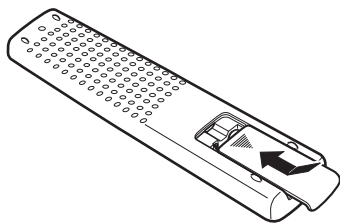

■ Cautions on handling batteries

Misuse of the batteries can result in electrolyte leakage, rupturing, corrosion, etc.

Bear in mind the following points when using batteries.

- Remove the batteries from the remote control unit if the unit is not going to be used for a prolonged period (a month or more).
- Do not use an old battery together with a new one.
- Insert the batteries while ensuring that their \oplus and \ominus poles are properly aligned with the corresponding markings on the remote control unit.
- Batteries with the same shape may have different voltages. Do not use different types of batteries together.
- If electrolyte has leaked, thoroughly wipe the inside of the battery compartment, and then insert new batteries.
- When batteries which are no longer required are to be discarded, follow the directions (regulations) laid down by the local authorities in the area concerned for their disposal.

■ Usage of remote controller

Operational range

Operate the unit with the remote controller within the range of the illustration below.

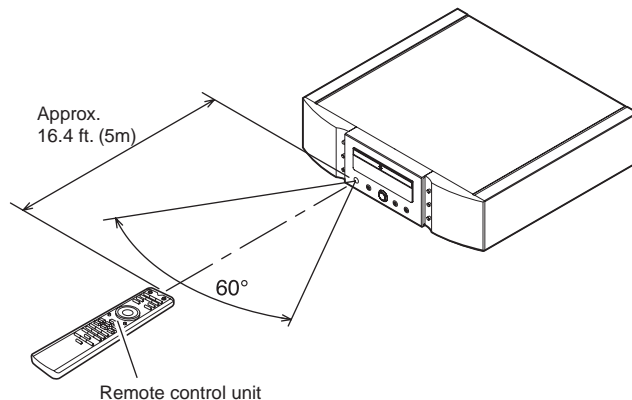

Precautions

- Do not allow direct sunlight, an inverter fluorescent light or other strong source of light to shine onto the player's infrared signal reception window (remote sensor). Otherwise, the operation of the remote control unit may be disabled.
- Bear in mind that operating the remote control unit may cause other devices operated by infrared rays to be operated by mistake.
- The remote control unit cannot be operated if the space between the controller and the player's remote sensor is obstructed.
- Do not place any objects on top of the remote control unit. Doing so may cause one or more buttons to be held down which will cause the batteries to run down.

NAMES AND FUNCTIONS

FRONT PANEL

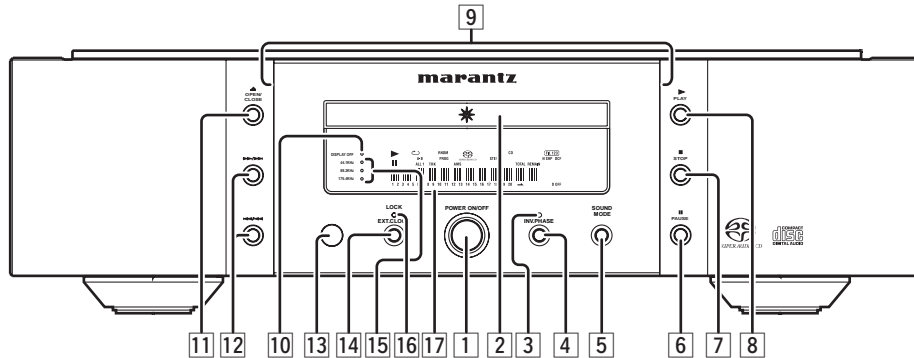

1 POWER ON/OFF switch

This switch is used to turn the power ON and OFF. When it is pressed, the display window lights up, and the power comes on. When it is pressed again, the display window is extinguished, and the power goes off.

2 Disc tray

The disc to be played is placed on the tray.

Note:

Close the tray by pressing the operation button, not by pressing it in with your hand.

3 INV. PHASE (Inverted phase) indicator

This lights when the INV. PHASE button is pressed, and the phase of the signal from the ANALOG OUTPUTS connector (BALANCED, UNBALANCED) is being inverted.

4 INV. PHASE (Inverted phase) button

Press this button to invert the phase of the signal from the ANALOG OUTPUTS connector (BALANCED, UNBALANCED). (See page 23)

5 SOUND MODE button

Press this button to select the Super Audio CD sound mode. Super Audio CD (stereo) or Audio CD (if discs are supported) (See page 15)

6 PAUSE button

Press this button to pause playback. If pressed again, the unit returns to playback.

7 STOP button

Press this button to stop playback. Also this button is used to clear all programs.

8 PLAY button

Press this button to start playback.

9 Illumination lamp

This lamp lights when the display window lights. This lamp may always remain off for certain settings. (See page 20)

10 DISPLAY OFF indicator

This indicator turns on when the LCD screen is turned off (Off mode).

11 OPEN/CLOSE button

Press this button to open the tray. Put on a disc label side up. Press the button again to close the tray.

12 (Track Skip/Search buttons)

These buttons can be used as both track skip and track search buttons. (The buttons on the main unit only.)

◀◀ : When this button is pressed, the unit goes back to the beginning of the current track. If the button is pressed more times, the track being played is skipped back. When this button is held down, tracks are searched backward (Fast Rewind).

▶▶ : Each time this button is pressed, the track being played is skipped forward. When this button is held down, tracks are searched forward (Fast Forward).

In program play, Fast Forward and Fast Rewind can be done in the playing track only.

13 Remote sensor

The infrared control signal emitted from the remote control unit are sensed here.

14 EXT. CLOCK (External clock) button

Press this button to match the frequency with the master clock generator connected to the unit. (See page 22)

15 EXT. CLOCK (External clock) indicator

When the EXT. CLOCK button is pressed, one of the unit's clock frequency indicators (44.1 kHz, 88.2 kHz, 176.4 kHz) turns on.

Every time the EXT. CLOCK button is pressed, the clock frequency indicator changes. (See page 22)

Note:

When the 44.1kHz, 88.2kHz, and 176.4kHz indicators are all on at the same time, the internal memory is being reorganized. This is not a malfunction. Do not switch off the power during this process.

16 LOCK (lock) indicator

This turns on when the EXT. CLOCK button is pressed, and the EXT. CLOCK indicator clock frequency and the master clock generator clock frequency match (synchronize). (See page 22)

17 LCD

This screen shows the operating status.

NAMES AND FUNCTIONS

DISPLAY

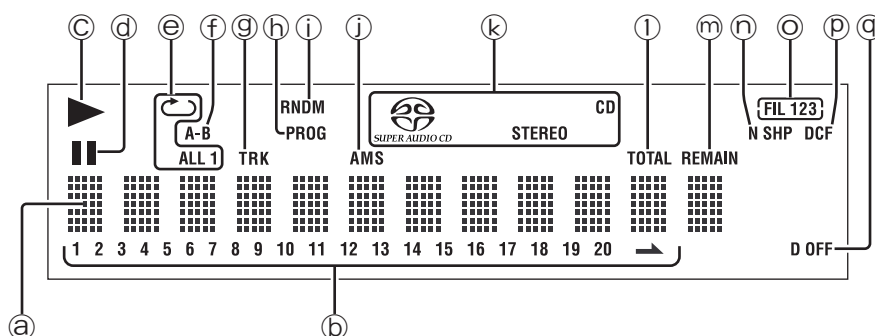

Ⓐ Main display

The time display and text information of the disc to be played as well as the setting menus and other displays appear on the main display.

Ⓑ 1-20, (music calendar)

The number of tracks recorded on the disc to be played, the number of remaining tracks to be played, and the number of tracks programmed by program play appear here. "" light when 21 or more tracks have been recorded on the disc.

Ⓒ (play) indicator

This lights during disc play.

Ⓓ (pause) indicator

This lights when play is paused (temporarily stopped).

Ⓔ , ALL, 1 (repeat) indicator

This lights during repeat play.

Ⓕ A-B (A-B repeat) indicator

This lights during A-B repeat play.

Ⓖ TRK (track) indicator

This lights above the display of the track number now playing, for instance.

Ⓗ PROG (program) indicator

This lights during program play.

Ⓘ RNDM (random) indicator

This lights during random play.

Ⓙ AMS (automatic music scan) indicator

This lights during AMS playback.

Ⓚ CD, Super Audio CD, STEREO Disc indicator

This indicates the type of disc on the disc tray.

Ⓛ TOTAL (total time) indicator

When the total remaining time or the total program time is displayed, this lights above the display.

Ⓜ REMAIN (remaining time) indicator

When the remaining playback time of a track is displayed, this lights above the display.

Ⓝ N SHP (noise shaper) indicator

This lights when the noise shaper is turned on. (See page 20)

Ⓞ FIL 1 2 3 (filter 1, filter 2, filter 3) indicator

This indicates which filter among filter 1, filter 2, or filter 3 is currently selected. (See page 21)

Ⓟ DCF (DC filter) indicator

This lights when the DC filter is turned on. (See page 20)

Ⓠ D OFF (digital output off) indicator

This lights when the digital output setting for the CD signal is set to off. (See page 20)

NAMES AND FUNCTIONS

REAR PANEL

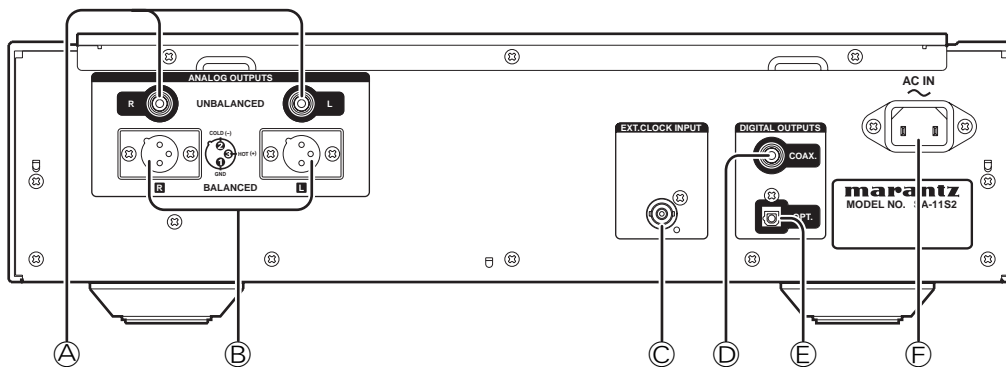

Ⓐ ANALOG OUTPUTS UNBALANCED connectors

These are the unbalanced output jacks of the analog audio signals. The analog connection cord can be connected to the CD, AUX, or other connectors on an amplifier. Be sure to connect the L and R channels correctly to the corresponding jacks.

Note:

Never connect to the PHONO connector on the amplifier.

Ⓑ ANALOG OUTPUTS BALANCED connectors

These are the balanced output jacks of the analog audio signals. A balanced connection cord (available commercially) can be connected to the balanced input jack of the amplifier. Be sure to connect the L and R channels correctly to the corresponding jack. (See page 23)

Note:

If connecting the balanced output jacks, be sure to leave the unbalanced jacks unconnected. (The balanced and unbalanced connectors cannot be used at the same time.)

Ⓒ EXT. CLOCK INPUT (External clock) Connector

This is the input connector for the clock frequency from an external master clock generator.

Connect the master clock generator to the BNC terminal coaxial cable (75 Ω).

Ⓓ DIGITAL OUTPUTS COAX. (Coaxial digital output connector)

The audio CD signal being played is output digitally. Connect a recording device, amp, D/A converter etc. that has a coaxial digital input connector using a commercially available coaxial cable.

Notes:

- No signal is output when Digital Out OFF is set.
- No signal is output when playing a super audio CD.

Ⓔ DIGITAL OUTPUTS OPT. (Optical digital output connector)

The audio CD signal being played is output digitally. Connect a recording device, amp, D/A converter etc. that has an optical digital input connector using a commercially available square-shaped optical cable.

Notes:

- No signal is output when Digital Out OFF is set.
- No signal is output when playing a super audio CD.

Ⓕ AC POWER INPUT JACK

Connect the supplied power cord to this jack and a household AC power outlet.

NAMES AND FUNCTIONS

REMOTE CONTROLLER

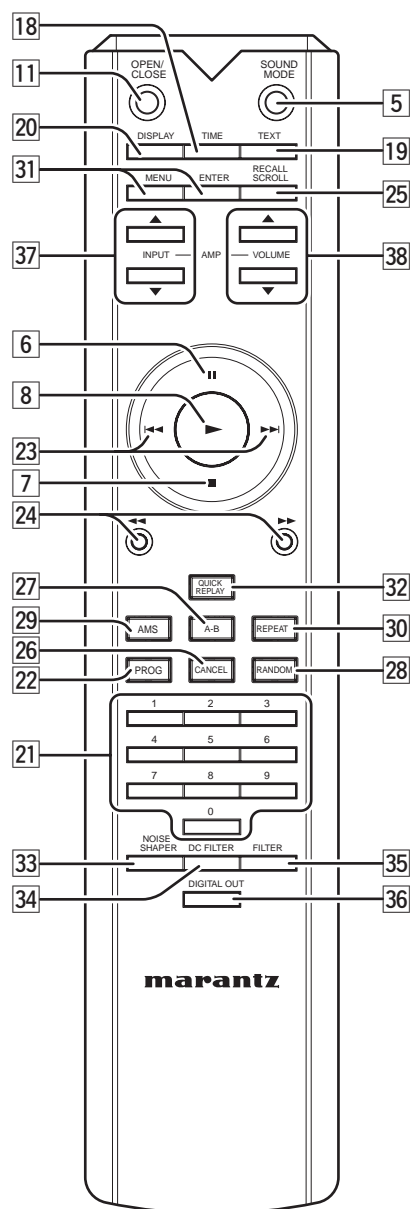

In this instruction manual, some operations can only be performed with the remote control. For operations that can be performed with buttons both on the main unit and on the remote control, the button names are shown in the mark. And for operations that can only be performed with buttons on the remote control, the button names are shown in the mark.

5 **SOUND MODE** button

6 **PAUSE** button

7 **STOP** button

8 **PLAY** button

11 **OPEN/CLOSE** button

The buttons listed above are the same to the buttons on the front panel of the main unit.

Please see the correspond items in "Front Panel" section.

18 **TIME** button

This button is used to switch from the text display to the time display when using a text-compatible Super Audio CD. It is also used to change the time display.

Each time that it is pressed, the displayed time cycles from track elapsed time → track remaining time → total remaining time → track elapsed time. (See page 14)

19 **TEXT** button

This button is pressed to switch the main screen from the time display to the text display when using a text-compatible Super Audio CD. (See page 19)

20 **DISPLAY** button

This button switches the display screen on and off.

The 10 indicator turns on when Display Off is set. (See page 20)

21 **0 - 9 (Numerical buttons)**

Use these buttons to select tracks directory.

22 **PROG.** button

This button is for program play. (See page 17)

23 ◀◀, ▶▶ **(Track skip buttons)**

◀◀ : When this button is pressed, the unit goes back to the beginning of the current track. If the button is pressed more times, the track being played is skipped back.

▶▶ : Each time this button is pressed, the track being played is skipped forward.

Note:

Search buttons are provided separately for the remote control unit. Use 24 Search buttons for search function.

24 ◀◀, ▶▶ **(Search buttons)**

◀◀ : While this button is pressed during playback, tracks are searched backward.

▶▶ : While this button is pressed during playback, tracks are searched forward.

NAMES AND FUNCTIONS

25 **RECALL/SCROLL button**

Use this button to scroll text while displaying text information in a Super Audio CD disc that supports TEXT.

This button is also used for checking the programmed tracks during a program or when a program is stopped. (See page 18)

26 **CANCEL button**

Use this button to cancel a programmed track. (See page 18)

27 **A-B (A-B Repeat button)**

This button is to determine starting and ending points for A-B repeat play. (See page 16)

28 **RANDOM button**

This button is for random play. (See page 17)

29 **AMS (Automatic Music Scan button)**

Use this button for AMS play. (See page 18)

30 **REPEAT button**

This button is for repeat play. Each time this button is pressed, repeat mode changes as follows.

“All Repeat” → “Track Repeat” → “Repeat Off” (See page 16)

31 **MENU button and ENTER button (Menu setup)**

These buttons are used to set the time for quick replay. (See page 19)

32 **QUICK REPLAY (Quick replay) button**

This button is used to do quick replay of the tracks. (See page 19)

33 **NOISE SHAPER button**

This button is pressed to turn the noise shaper on and off. (See page 20)

34 **DC FILTER button**

This button is pressed to turn the DC filter on and off. (See page 20)

35 **FILTER button**

This button is pressed to make the digital filter settings. Each time it is pressed, the settings cycle from FIL1 → FIL2 → FIL3 → FIL1. (See page 21)

36 **DIGITAL OUT button**

This button is pressed to turn the digital output for the Audio CD signal on and off. (See page 20)

37 **INPUT button**

This button is pressed to switch the input when using one of the supported Marantz amplifiers.

This function, however, may not work on some older models.

38 **VOLUME button**

This button can be used to adjust the volume when a Marantz amplifier that has a remote control is used.

CONNECTIONS

Depending on your amplifier/receiver/Stereo System, there are various ways to connect to this player. For correct connection please refer to instruction manuals of stereo system to be connected.

Caution:

Do not connect output from this unit to PHONO input of your audio system.

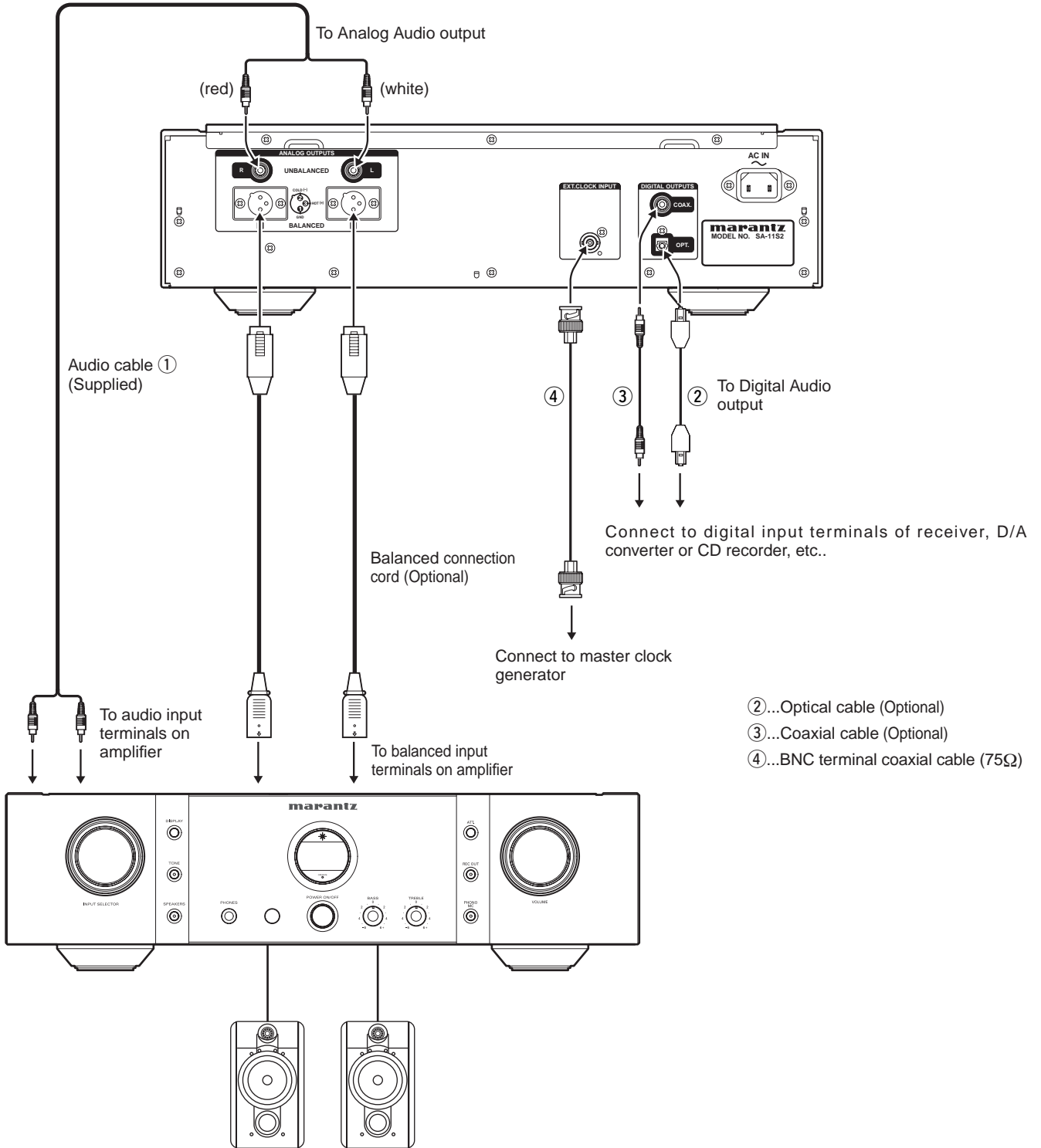

CONNECTIONS

1. Connect the audio cable ① to this unit's front speaker outputs and the stereo inputs on your amplifier, receiver or stereo system.
2. Connect the optical cable ②, coaxial cable ③ to the digital input on your AV amplifier, D/A converter, CD-R, etc..
* Signal will be output from the digital audio out jacks (OPT./COAX.) only when an Audio CD disc is played. No signal is output when playing a Super Audio CD.
3. When connecting to an external master clock generator, use the BNC terminal coaxial cable (75Ω) ④.

Note:

Signals are output from the DIGITAL OUTPUTS connector (OPT., COAX.) only when an audio CD is being played. No signal is output when playing a super audio CD.

CONNECTING THE POWER SUPPLY

- 1 Plug the power cable into AC IN jack on the back panel.

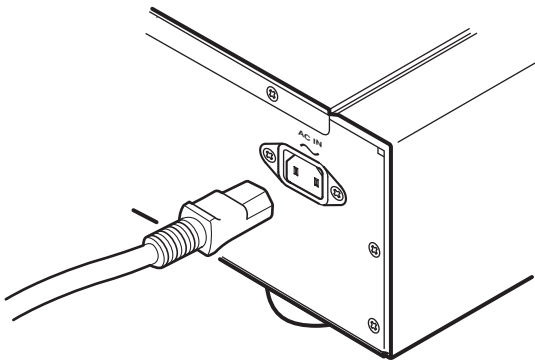

- 2 Turn on the power switch of the audio unit (amplifier, etc.) that is connected with this unit. Set the selector on the connected unit to this unit.
- 3 Plug the power cable into an AC outlet.

TIMER PLAY

This unit can perform timer play by cooperating with your audio timer.

Connect this unit's power cord to the audio timer's power socket and the timer's power cord to power outlet.

For connection to audio timer and it's operation, please refer to the instruction manual of your audio timer.

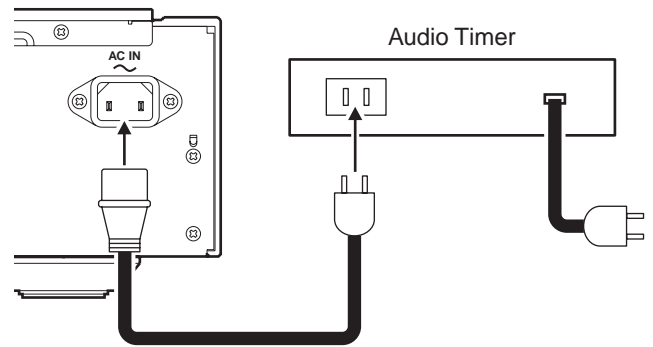

Setting method of Timer Play

- ① Press POWER switch to turn ON the power.
- ② Insert the disc to be played.
* In timer play mode, tracks are played normally.
- ③ Set the audio timer.

OPERATION

NORMAL PLAYBACK

■ Super Audio CD player playback

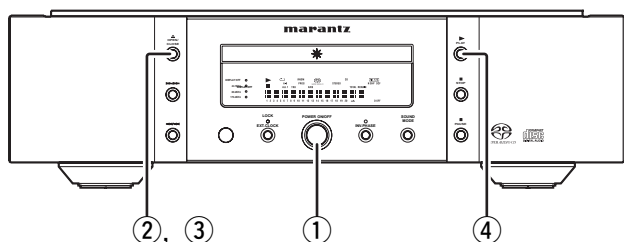

① Press POWER switch to turn on.

LCD

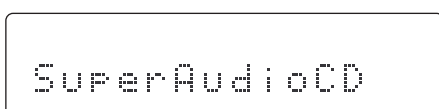

The display cycles from TOC Reading → No Disc (when no disc is loaded) → Super Audio CD (when the start sound mode setting is Super Audio CD).

② Press the button

The disc tray comes out. Place the disc with label side up on the tray.

To play a single (8cm) CD, place the disc with the indentation at the center of the tray.

③ Press button.

④ Press button.

Disc type is automatically detected and playback is started. Track number and track elapsed time(minute, second) appear on the display.

- For Super Audio CD/CD hybrid-layer discs (See page 3), the layer that is set in the start sound mode (See page 15) is played. To change the layer, use the button. (See page 15)

(Exp.:Track 6, Elapsed time 2 min 8 sec)

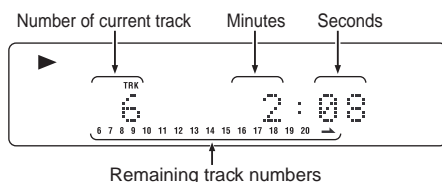

Playback automatically stops at the end of the final track.

To start playback form the first track

Press button.

To stop playback

Press button.

To eject disc

Press button to open the disc tray and take the disc off. Press the button again to close the tray. Disc tray must be closed when the unit is not be used.

To pause playback

Press button.

PAUSE indicator will light and playback is paused at the point that the button is pressed. To restart playback, press button again or press button.

To change time display

Press the button on the remote control.

Each time button is pressed, display will change in the following order. "Track elapsed time" → "Track remaining time" → "Total remaining time" → "Track elapsed time".

• **Track remaining time**

(The remaining playing time from the playing point to the end of the current track)

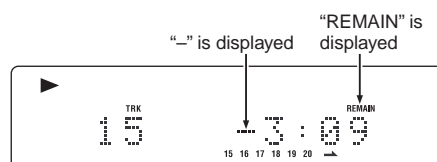

• **Total remaining time**

(The remaining playing time from the playing point to the end of the last track)

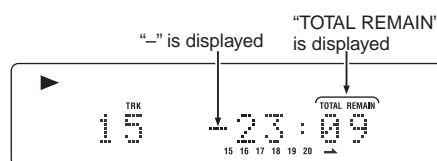

- If button is pressed when Super Audio CD disc that supports text is in use, time display is given priority and the text information will not be displayed afterward. To see the text information, press button.

OPERATION

SWITCHING SOUND MODE (SUPER AUDIO CD)

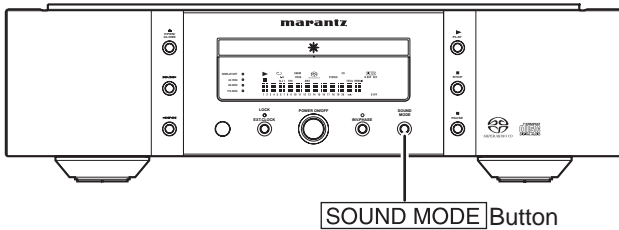

① Press **SOUND MODE** button in stop mode (not playing).

The currently selected layer or area is shown on the LCD. (CD or Super Audio CD)

If **SOUND MODE** button is pressed again, a playable layer or area will be shown, and the layer or area will be switched to new one.

- When layer or area is switched, TOC will be read again.
- The sound mode cannot be changed for Audio CDs and discs with only a Super Audio CD area.
- The sound mode on hybrid layer discs will be changed in the following order.
Super Audio CD stereo area → CD layer → Super Audio CD stereo area
- Sound mode can be selected while the tray is open. Select a desired layer or area and press **▶ PLAY** button then the tray will close and playback will be started.

② Press the **SOUND MODE** button during playback.

The currently selected layer or area is shown on the LCD. (CD or Super Audio CD)

If **SOUND MODE** button is pressed again, the playback is stopped, and the layer or area will be switched to new one.

When you want to listen at that area, press **▶ PLAY** button again. The playback will be started.

START SOUND MODE

When a Super Audio CD hybrid layer discs that has both a Super Audio CD high sound quality stereo area and an Audio CD area information are to be played, this player makes it possible to set the layer/area (Super Audio CD or Audio CD) to be preferentially played.

This setting can be made when the tray is closed and there is no disc in the disc tray.

- ① Press **SOUND MODE** button on the player.
The currently selected layer/area is displayed.
If the Super Audio CD is selected : Super Audio CD
If the Audio CD is selected : CD
- ② Press the **SOUND MODE** button again to display the layer/area to be played first, and then leave the setting for at least two seconds to register the setting for the start sound mode.

Caution:

- Start sound mode has a memory retention function where the settings remain stored and unchanged even when the disc is changed or the power is turned off.
- At the time of shipment, the sound mode is set to Super Audio CD.

OPERATION

PLAYING YOUR FAVORITE TRACKS OF A DISC

■ Specify track number to play (Direct Search)

Specify track number with numerical buttons (0-9) on the remote

(example)

3rd track : Press **3**.

12th track : Press **1** and then press **2** (within approximately 1.5 seconds).

If the first pressed number is only in the digit of ones and not in the digit of tens, search begins approximately 0.5 second after.

If a wrong number is pressed

Press correct number again.

- If a track number that is not in the disc is specified, "No Track" will be shown on the main display. Please specify a correct track.

■ Skipping to the previous or next track (Track Skip)

To listen to a track posterior to the current track

Press the **▶▶** button on the remote or the unit the same number of times as the number of tracks you want to advance.

To listen to a track prior to the current track

If the **◀◀** button is pressed on the unit or the remote while playing a track, playback starts again from the start of the current track.

Continue to press the **◀◀** button for the same number of times as the number of tracks you want to return.

PLAYING YOUR FAVORITE PARTS OF A DISC (SEARCH)

If **◀◀**, **▶▶** buttons on the main unit or **◀◀**, **▶▶** buttons on the remote are kept pressing during playback, track search begins. Release the button when the point you want to listen to gets close.

Note:

No sound is output during the search operation.

REPEATED DISC PLAY (REPEAT PLAY)

■ All track repeat

When **REPEAT** button on the remote is pressed, "ALL" indicator will light up and all track repeat play begins.

To Return to Normal Play

Press **REPEAT** button two times. "ALL" indicator will disappear, repeat mode will be off and it returns to normal play mode.

If **REPEAT** button is pressed when in program mode, programmed tracks are played repeatedly.

■ One Track Repeat

Press **REPEAT** button on the remote two times.

"1", "1" indicators will light and the track will be played repeatedly.

To Exit from One Track Repeat

Press **REPEAT** button. "1" indicator will disappear, repeat mode will be off and it returns to normal play mode.

■ A-B Repeat

① Press **A-B** button on the remote at your chosen starting point. The "A-" indicator will blink.

② Press **A-B** button again at your chosen end point. "A-B" indicator will light up and the chosen section will be played repeatedly.

To Exit from A-B Repeat

Press **A-B** button on the remote. "A-B" indicator will disappear, A-B repeat mode will be off and it returns to normal play mode.

Notes:

- A-B repeat cannot be done when random play is going on.
- The end point (where "A-" indicator is blinks) of the repeat section cannot be set before the time of the starting point (where "A-B" indicator light up) of the repeat section.

OPERATION

PLAYING TRACKS IN A RANDOM SEQUENCE (RANDOM PLAY)

When **(RANDOM)** button on the remote is pressed in stop mode, and then **(▶PLAY)** button is pressed, the unit shuffles track order automatically and plays all the tracks in the shuffled order. The RNDM (random) indicator lights.

- The gap between tracks will be approximately 2 seconds during random play.

To Exit from Random Play and Return to Normal Play

Press the **(■STOP)** button, and then press the **(RANDOM)** button while playback is stopped.

The RNDM (random) indicator goes off, and random play is released.

If **(▶▶)** buttons on the main unit or **(▶▶)** button on the remote are Pressed during Random Play

It jumps to the next track of the shuffled order.

If **(◀◀)**, **(▶▶)** buttons on the main unit or **(◀◀)**, **(▶▶)** buttons on the remote are Pressed during Random Play

Search will be done only in the current track. Search does not go to the previous or next track.

To Listen to Random Play Repeatedly

Press **(REPEAT)** button on the remote once during random play. Every time the order will be shuffled.

- If **(RANDOM)** button is pressed during program play, the programmed tracks will be shuffled.

PLAYING TRACKS IN A SPECIFIC SEQUENCE (PROGRAM PLAY)

You can arrange and play tracks in a specific sequence. Up to 30 tracks to be played can be programmed.

(Example: To program the 7th track after 15th track in a disc with 25 tracks)

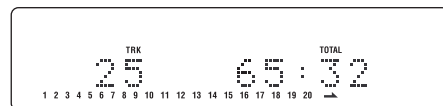

- 1 Press **(PROG.)** button on the remote in stop mode. "PROG" indicator will blink and it goes to program mode.

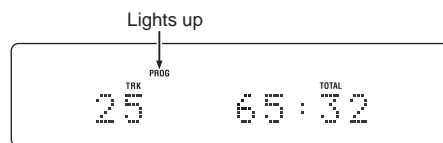

- 2 Choose a track to be programmed with numeric buttons on the remote.

(Example: The 15th track is chosen and it's length is 4min30sec)

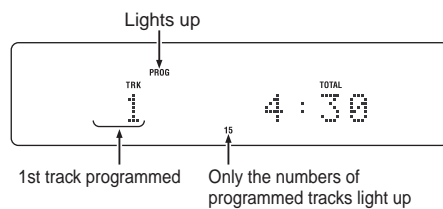

- 3 With the sequence described in step 2 above, program another track. Repeat that sequence to program all the tracks you want. You can program up to 30 tracks.

(Example: The 7th track is chosen and total length of 7th and 15th is 7min50sec)

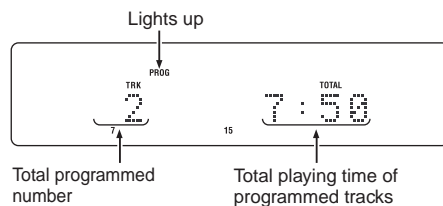

- 4 Press **(▶PLAY)** button to starts playback in programmed order.

When 21 or more tracks are programmed, **(▶)** will light up instead of the track number indicator.

OPERATION

To Check the Programmed Tracks

Press the **RECALL/SCROLL** button on the remote control during the program or when the program is stopped ("PROG" lights up).

Every time press **RECALL/SCROLL** button, the programmed tracks will be displayed one after the other in order.

To Delete a Programmed Track

① Press **CANCEL** button in stop mode when program has been made (When "PROG" indicator is lighting up).

② Everytimepress **CANCEL** button, the programmed tracks are deleted in order from the last track programmed.

Also, the deleted track's track number indicator will disappear.

To Clear Whole Program

Press **STOP** button two times while in program play. In the stop mode, press **STOP** button once.

Program can also be cleared by pressing **OPEN/CLOSE** key to open the disc tray.

To Add Tracks to Program

Tracks can be added to the end of program when program is remaining ("PROG" indicator is lighting up) and in stop mode.

However tracks cannot be added to the program when the RNDM (random) indicator is lit up.

* Please be careful about the following matters.

- When programming 1st through 9th tracks in a disc that has over 10 tracks by using numeric buttons. For instance, programming the 3rd track after programming the 1st track, press 3 button more than approximately 1.5 seconds after 1 button is pressed. When a program is finalized, the time is updated.
- Likewise, when programming a track at 10th or after. For example, to program 13th track, press 3 button within approximately 1.5 seconds after 1 button is pressed.
- When programming a track in a disc that has less than 9 tracks. For instance, to program the 5th track after 4th track has been programmed, press 5 button more than approximately 0.5 second after 4 button is pressed.

Q&A

• How many tracks can be programmed?

Up to 30 tracks can be programmed for program play.

• Can I listen to program play repeatedly?

Press **REPEAT** button once. "↺" "ALL" indicator will light and program play will be repeated.

• Can I shuffle the programmed track order?

Press **RANDOM** button in stop mode.

SEARCHING YOUR FAVORITE TRACKS (AMS (AUTOMATIC MUSIC SCAN) PLAY)

This feature is convenient to search where your favorite track is.

If the **AMS** button is pressed while a track is stopped, the AMS indicator lights up, and the first ten seconds of each track on the disc will be played starting from the first track.

Also, if the **AMS** button is pressed during playback, the AMS indicator lights up, and the program jumps to the next track after approximately 10 seconds elapses on the display time.

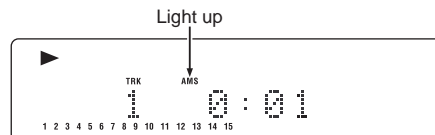

Once you find a song that you want to listen to, press the **AMS** button again or press the **PLAY** button. The AMS indicator turns off, and normal playback resumes from the current track.

Note:

If the **AMS** button is pressed after the tracks are programmed, only the programmed tracks are played by AMS.

OPERATION

QUICK REPLAY

When **QUICK REPLAY** button is pressed during playback, the unit goes back to the amount of time set by the MENU and starts playback from there.

* Playback that goes beyond the track is not allowed.

Also, when the total time of the track being played is shorter than the time set for quick replay, or when the playback time is shorter than the time set for quick replay, if **QUICK REPLAY** button is pressed, the track will be goes back to the start of that track and playback is started from there.

To Set Quick Replay Time

① If a disc is loaded in the disc tray, eject the disc and close the tray.

② Press the **MENU** button on the remote control.



③ Press the **ENTER** button on the remote control while Quick Replay is displayed (approx. 3 seconds). The current time setting appears on the LCD. (The default setting is 10 seconds.)

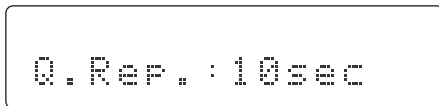

④ Use the **◀◀** or **▶▶** button to set the time. (5 to 60 seconds)

⑤ After making the setting, press the **MENU** button twice. The LCD returns to the normal display.

⑥ The time setting is retained even when the power is turned off.

Caution:

When there is no key input for about 3 seconds during this series of operations, the setting will be configured to the conditions at that time and the display will return the time display.

ABOUT THE TEXT INFORMATION DISPLAY

The following items of text information in Super Audio CD discs can be displayed by pressing **TEXT** button on the remote.

Nevertheless, which items of information are recorded depends on discs so some information may not be displayed. This unit skips unrecorded information to display.

• During playback

When **TEXT** button is pressed on the remote, "Track Title" of the currently playing will be displayed.

• In Stop Mode

Each time **TEXT** button on the remote is pressed, text information will be displayed in the following order.

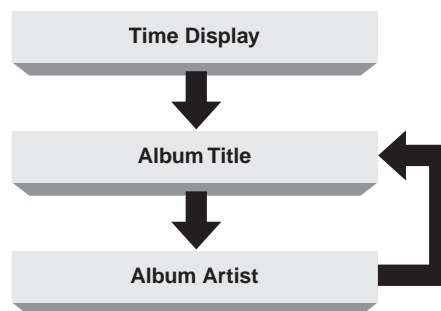

• This unit can display 12 characters in one time. If information is longer than 12 characters, the display will scroll right to left.

• This unit can display only alphabets, numeric numbers and symbols. Chinese and Japanese characters cannot be displayed. If information is in Chinese and Japanese characters, the unit displays nothing.

OPERATION

TURNING OFF THE DISPLAY AND ILLUMINATION (DISPLAY OPERATION)

This function is used to turn the LCD and illumination lamps (blue) on and off. (Two display statuses are available.)

- Mode where LCD and illumination lamp (blue) turn on
Each time the **DISPLAY** button is pressed during playback, the LCD and illumination lamp (blue) switch on and off.
When Display Off is set, the Display Off indicator (red) lights up.
 - When any related button is pressed (such as when the **OPEN/CLOSE** button, **STOP** button, or **SKIP** button is used), the display is automatically turned on, but the Display Off indicator (red) remains lit. If a track is started in this state, the display is automatically turned off two seconds later.
 - When a track is stopped, the Display Off indicator (red) and illumination lamp (blue) light up alternately.
- Setting for turning on only LCD (illumination lamp (blue) remains off)
In the default state, the illumination lamp (blue) is lit. In this state, the illumination lamp (blue) remains off regardless of whether the LCD is turned on or off.

Changing procedure (Changes can be made when operation is stopped.)

- If playback is in progress, press the **STOP** button to stop playback. To make the setting, hold down the **DISPLAY** button for at least two seconds from the remote control.
- If the illumination lamp (blue) is lit, it is turned off and is set off. To change the setting from off to on, hold down the same operation **DISPLAY** button for at least two seconds to turn on.
 - The illumination lamp (blue) off setting is retained even when the power is turned off, and this setting remains until the setting is changed to the on setting.
 - The LCD display on/off setting is not retained when the power is turned off. (This enables you to enjoy operation each time you use it.)

MAKING YOUR FAVORITE AUDIO SETTINGS

The settings can be made using the remote control. The settings are retained even if the power is turned off so that you can always enjoy tracks with your favorite characteristics. To change the settings again, make the changes using the same procedure. The settings can be changed when the track is stopped.

■ Playing the CD layer of an audio CD or Super Audio CD

① Noise shaper operation

In this unit, you can select noise shaper on or off for playing tracks.

The noise shaper is turned on and off by pressing the **NOISE SHAPER** button while the track is stopped. When turned on, the NSHP indicator lights up on the LCD.

* Noise shaping is a type of digital feedback used in the algorithms for oversampling. Digital feedback improves the linearity of bass sounds and the noise characteristics of the audio frequency band. However, this digital feedback is still feedback nonetheless. Generally, in amplifiers and other equipment, the sound quality changes based on the amount of feedback. Low feedback is said to result in poor audio characteristics but good sound.

Although no measurement differences are shown in the unit, the sound quality is changed. Therefore, make the setting according to your preferences.

② DC filter operation

The DC filter is turned on and off by pressing the **DC FILTER** button while the track is stopped. When turned on, the DCF indicator lights up on the LCD.

* The DC filter is effective when the speakers vibrate abnormally for discs with recorded audio having extremely low noise characteristics. (The cutoff frequency is set to 1.7Hz.)

③ Digital output off operation

The digital output function is turned on and off by pressing the **DIGITAL OUT** button while the track is stopped. When digital output is turned off, the D OFF indicator lights up on the LCD.

- When digital output is not used, setting to digital output off enables you to enjoy better sound quality.

Note:

The noise shaper, DC filter, and digital output off have a memory retention function where the settings remain stored and unchanged even when the disc is changed or the power is turned off.

OPERATION

④ Filter operations

The filter settings can be made while the track is stopped. The filters shown in the table below are available for providing distinctive filtering according to the operation and Audio CD or Super Audio CD.

Each time the **(FILTER)** button is pressed, the filter types cycle from FIL1 → FIL2 → FIL3 → FIL1.

The filter setting has a memory retention function so that the setting remains stored and unchanged even when the disc is changed or the power is turned off.

Filter Selection Table

This unit is equipped with the "PEC 777f2" filter, developed with an improved algorithm from the digital filter for CD playback "SA-11S1" (Phase Error Compensation 777 filter) that uses Marantz original DSP.

When playing a super audio CD, the D/A converter internal filter is used.

The filter has 3 types of built-in characteristics for both Audio CDs and Super Audio CDs, and the characteristics for each are shown in the table below. Change these settings according to your own personal preference.

Filter type	Audio CD	Super Audio CD
FILTER 1	This filter impulse response has a symmetrical and very short pre-echo and post echo characteristics. The phase response is absolutely linear. It reproduce all information of the recording in detail. The sound image is very profound, clear and very nice to listen to.	Filter 1 does not touch the digital data stream coming from the Super Audio CD. It is the direct mode. The original source data is reproduced without any alteration. The maximum available bandwidth will be used. In combination with Marantz amplifiers this filter will provide the most accurate reproduction.
FILTER 2	This filter impulse response is asymmetrical and has a post echo which is slightly longer than the pre-echo. The characteristic is close to the sound of analog - it is well balanced between detailed and harmonic sound.	Filter 2 dampens frequencies in the digital data stream from the Super Audio CD which are over the 100kHz to lower the bandwidth. In addition, operations within the D/A convertor are asymmetrical with priority given to resolution.
FILTER 3	This filter impulse response is symmetrical and has a very short pre-echo and post-echo. It provides high sound definition with the most detail along with a comfortable playback balance.	Filter 3 dampens frequencies in the digital data stream from the Super Audio CD which are over the 100kHz to reduce the bandwidth. Operations with the D/A convertor are fully symmetrical.

Note:

Select the right filter by auditioning. The correct one will depend on your system and your personal preference.

OPERATION

USING A MASTER CLOCK GENERATOR WHEN PLAYING DISCS

The master clock generator

In digital devices such as CD players or super audio CDs, there is a process that samples or restores the analog signal.

In order to conduct this process, a clock signal (sampling frequency) is used.

A master clock generator is an oscillation device that makes this clock signal.

The clock signal output by the crystal oscillator built into this unit is extremely accurate, enabling you to fully enjoy high quality sound playback. However, you can also perform playback using the clock signal output from an external master clock generator, to enjoy the difference in the sound that the master clock generator can provide.

In recent years, research has found that the difference in clock signals causes differences in tone quality. In response to this finding, many companies have released master clock generators.

Generally speaking, the more precise the clock signal time base is, the closer it is to the natural time base of the sound, thus enabling the reproduction of higher fidelity sound.

Therefore many master clock generators insist that they are capable of outputting a highly precise clock signal.

Anyway, the different clock seems give differences sound tone. This unit offers the possibility of enjoying the change.

The frequency of the clock signal that can be input into this unit is 44.1, 88.2, or 176.4kHz. Use a master clock generator that is capable of outputting these signals.

■ Using a master clock generator for playback

Should you elect to use an outboard master clock generator, be sure to select one that has an extremely accurate clock to avoid degrading the sonic performance of this unit.

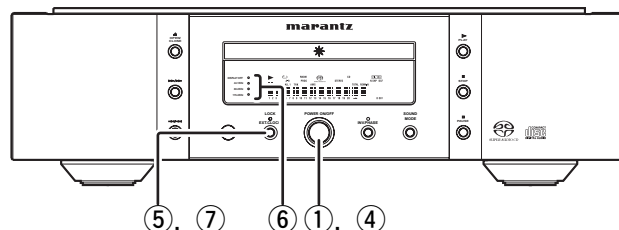

- ① Switch off the power supply.
- ② Connect the EXT. CLOCK INPUT connector on the rear of this unit to the output connector of the master clock generator using a commercially available BNC terminal coaxial cable. (See page 12)
- ③ Switch on the power of the master clock generator, and check the clock frequency to set. For details on this operation, please refer to the instruction manual that came with your master clock generator.
- ④ Press the POWER switch on this unit to switch on the power supply.
- ⑤ When the unit's LCD display is on, press the EXT. CLOCK button on the front of the unit.
- ⑥ Each time the EXT. CLOCK button is pressed, the clock frequency indicator lights in the window, in the order shown below.

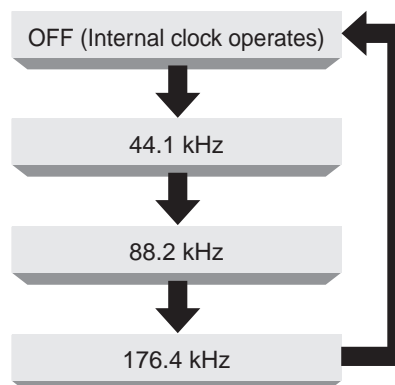

- ⑦ Press the EXT. CLOCK button to match the frequency with the clock frequency set in the master clock generator, and when the LOCK indicator switches on, the settings are complete.

You will be able to hear the changes in sound quality by changing the clock signal. Set the frequency to your own personal tastes.

Caution:

- Switch between the master clock generator and the internal clock when playback is stopped to prevent excessive sound occurrence from the speaker.
- Sound will be muted when the LOCK indicator blinks. Check the settings of your master clock generator, the connections etc. During this time, the DIGITAL OUTPUT signal will not be muted.
- The information after this operation is stored by the last memory function even after the power is switched OFF.

OPERATION

ABOUT BALANCED JACKS

- ① The balanced output connector uses a XLR connector.
- ② The XLR connector for professional use is internally wired in either of the following two systems.
 1. USA system (Pin ② = COLD, Pin ③ = HOT)

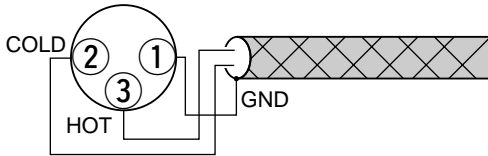

2. European system (Pin ② = HOT, Pin ③ = COLD)

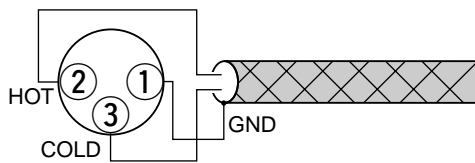

- ③ This unit uses the 1. USA system.

When a preamp or main amplifier adopting the European system is connected using a cable with XLR balanced connectors, the reproduced signal may be inverted of phase.

In this case, refer to “ANALOG OUTPUT CONNECTOR PHASE SWITCHING”, and set so that the correct phase is used.

ANALOG OUTPUT CONNECTOR PHASE SWITCHING

By digitally processing audio signals read by this unit, it is possible to perform phase inversion without changing the tone quality.

Inverted signals are output from the UNBALANCED output connector, and the BALANCED output connector interchanges between HOT and COLD signals.

As the USA system has been adopted for the BALANCED output connector, if the amp or other device used with this unit is a European system device, a phase inversion cable would normally need to be used to playback with the correct phase. However, by pressing the INV. PHASE button on this unit, you can listen to the correct phase without replacing the cable.

Moreover, if a disc that has been recorded with the incorrect phase is being played, you can play it in the correct phase by pressing the INV. PHASE button.

To change the mode

Every time the INV. PHASE button on the front of this unit is pressed, the phase of the signal being output from the ANALOG OUTPUTS connector (BALANCED, UNBALANCED) is inverted. The indicator flashes during inverted playback.

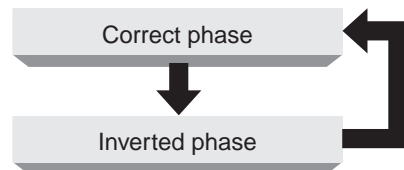

Caution:

- Phase switching is only possible when the LCD display is turned on.
- If switching is performed during playback, sound output is stopped for approximately one second to prevent the occurrence of unnecessary noise.
- The information after this operation is stored by the last memory function even after the power is switched OFF.

TROUBLE SHOOTING

If you think a malfunction has occurred, first check the points listed below. The problem is likely to have been caused by a simple operational error or a connection problem. If the problem cannot be corrected even after carrying out the following checks, consult your dealer or nearest Marantz sales office or service counter.

- **The disc fails to rotate.**

1. Is the mains lead plugged in properly?
2. Is the POWER switch ON?
3. Is the disc placed in the correct position on the disc tray?
4. Is the disc placed properly with the label side facing up?
5. Is the disc dirty?
6. Is the disc scratched?
7. Is the disc warped?
8. Is EXT. CLOCK (BNC terminal) connected? Also, is it set correctly?

- **The disc is rotating but no sound is heard.**

1. Are the amplifier and speakers connected properly?
2. Is the amplifier switch ON?
3. Is the amplifier's function or selector switch set to "CD" or "AUX" or such (to whatever you have connected this unit to)?
4. Is the amplifier's volume control set at the minimum level?

* Occasionally, sound may stop if the equipment is installed near an air conditioning unit or refrigerator. If this problem occurs, either switch the main power off and on again, or press the OPEN/CLOSE button to open and close the tray, then try playing the disc again.

- **The disc stops in mid-operation.
The sound drops out or noise is heard.**

1. Is the disc dirty?
2. Is the disc scratched?
3. Is the disc warped?

* In the case of a CD-R or CD-RW disc, this problem may occur when the conditions under which its data was originally written were substandard or when the quality of the disc itself is poor.

* This condition may occur in Mixed-Mode CDs, CD Extra, and other discs that have CDDA format mixed with other data.

Noise may also be heard momentarily when skipping tracks.

- **Remote control operation is not possible.**

1. Is the transmitter of the remote control unit pointed correctly at the remote sensor on the front of the player (this unit)?

Or is there an obstruction between the transmitter and the remote sensor?

2. Are the batteries in the remote control unit exhausted?
3. Is there another strong light (from a window, etc.) striking the Super Audio CD player's remote sensor?

- **A Super Audio CD cannot be played.**

1. Is the disc scratched, dirty or warped?
2. Is the amplifier's input selector set to digital? (Digital audio signal will not be output when a Super Audio CD is played.)
3. Is the disc a Super Audio CD multi-channel only disc? (This unit does not support Super Audio CD multi-channel.)

- **A CD-R/CD-RW disc cannot be played.**

1. Is the disc placed upside down?
2. Is the disc contains properly written TOC?
3. Is the recorded information in an audio (CD-DA) format?

- **A specific CD cannot be played**

Copy control CDs (CDs with copy guard) are special discs that do not comply with current CD standards. Marantz cannot guarantee the ability to play such discs on your CD player.

When normal CDs can be played without a problem and problems occur only when playing these special discs, it is not a problem with this unit.

Please ask the seller of the copy control CD for detailed information regarding copy control CDs.

- **The unit makes a clicking sound when the tray closes**

This is the adhesion click of the clasper for securing the disc. This does not cause any problem in using the unit.

- **While the disc is spinning, a spinning sound is heard or a slight vibration occur.**

Depending on the disc, a spinning sound may occur or the unit may vibrate slightly due to disc eccentricity or such. This is not a problem with this unit.

SPECIFICATIONS

	Super Audio CD	Audio CD
Audio Characteristics		
Analog output		
Channels	2channels	2channels
Frequency range	2Hz — 100kHz	2Hz — 20kHz
Frequency characteristics	2Hz — 50kHz (-3dB)	2Hz — 20kHz
Dynamic range	114dB (Filter 3)	100dB (Filter 1)
S/N Ratio (A-weighted)	112dB (Filter 3)	115dB (Filter 1)
THD (1kHz)	0.0009% (Filter 3)	0.0020% (Filter 1)
wow & flutter	Precision of quartz	Precision of quartz
Output level		
Unbalanced	2.5V RMS stereo (Filter 3)	2.3V RMS stereo (Filter 1)
Balanced	5V RMS stereo (Filter 3)	4.6V RMS stereo (Filter 1)
Digital output		
output level (cinch JACK)	—	0.5Vp-p (75Ω)
output level (optical)	—	-19dBm
Ext. Clock input		
Clock frequency	44.1kHz, 88.2kHz, 176.4kHz	
Input level (BNC terminal)	1V—5Vp-p (75Ω)	
Optical Readout System		
Laser	AlGaAs	AlGaAs
Wave length	650nm	780nm
Signal format	1-bit DSD	16-bit linear PCM
Sampling frequency	2.8224MHz	44.1kHz

Power Supply

Power requirementsAC 120V 60Hz
 Power Consumption 26W

Cabinet, etc.

Dimensions (Width x Height x Depth)
 17-5/16 x 5 x 16-1/4 ins. (440 x 127 x 413mm)
 Net weight 36.4 lbs (16.5kg)
 Operating temperatures +5°C ~ +35°C
 Operating humidity 5 ~ 90% (without dew)

Accessories

- Remote control unit 1
 Dimensions (Width x Height x Depth)
 1-15/16 x 13/16 x 9 ins. (48.5 x 20 x 227.5mm)
 Net weight 0.352 lbs (160g)
- AAA (R03) Batteries 2
- AC Power cord 1
- Audio cable 1
- User's Guide 1
- Warranty Card (USA) 1
- Warranty Card (CANADA) 1

Specifications subject to change without prior notice.

■ Dimensions (unit: inch (mm))

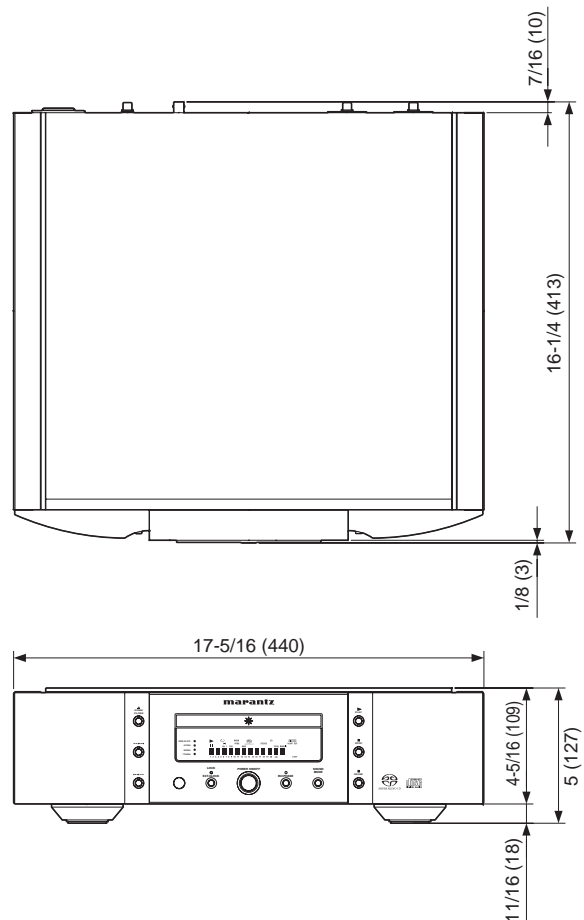

www.marantz.com

You can find your nearest authorized distributor or dealer on our website.

marantz[®] is a registered trademark.